

Clova

Leveraging Search Results to make Conversational Agents Smarter

NLP Group
Inho Kang

OVERVIEW - NAVER



Korea's largest Search Portal

74% of Search Market Share in South Korea
Search Engine + Various Online Services and Platforms



Knowledge-iN

Community QA platform. 400M Q&A database



NAVER Café, Blog and Post

2.3M blogs and 1M cafes

Daily 800K new user-generated documents



NAVER Dictionary and Encyclopedia

33+ languages, 3M knowledge entries



NAVER Shopping

700M+ products uploaded

from department stores to local, craft brands

OVERVIEW - LINE



Global messenger widely spread to 230 countries

Monthly active users of 200 million

The most popular messaging application in Japan, Thailand, Taiwan, and more

Evolving from a mobile messenger to global mobile portal (LINE Pay, LINE News, ...)



Clova : Cloud Virtual Assistant

NAVER and LINE team up to develop a General-purpose AI platform

Utilizes all contents accumulated by NAVER and LINE

Makes use of all AI technologies that NAVER and LINE have been developed

Synergies through Co-operation



General AI Platform

Goals:

Know you better
Get smarter everyday
Be with you everywhere

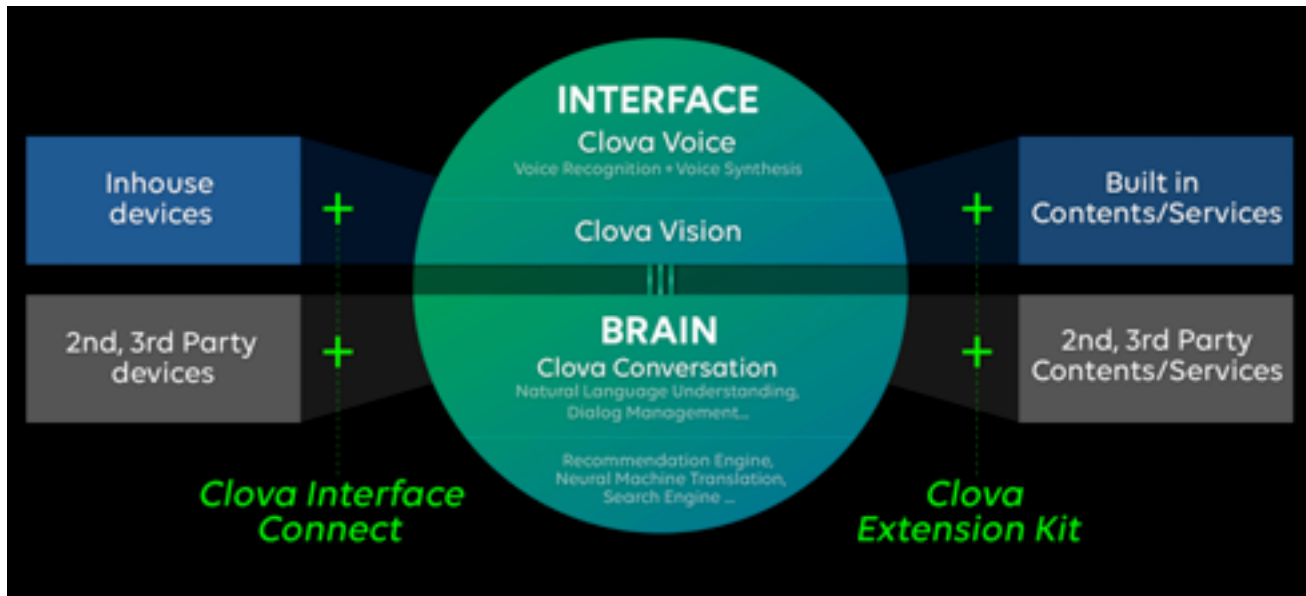

Clova Products

LINE's free voice-call function
Infrared home-appliance control

NAVER KOREA

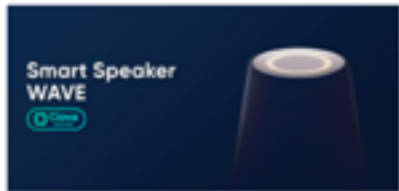

Wave (2017)



Friends (2017)



Friends Minions (2018)



Away and AKI (2018)



On (2019)

LINE JAPAN

LINE JAPAN



LINE
【XV-FRIENDS-カ】 Clova Friends Bros



LINE
【XV-FRIENDS-カ】 Clova Friends Sal



Friends Doraemon (2018)



TM & © Universal Studios



Clova Desk (2019)

Clova inside Products



Difficulties - Language Variation

Guide Sentence: **What did Tyrannosaurus eat?**



What do Tyrannosaurus eat?

What is Tyrannosaurus food?

What does the Tyrannosaurus eat?

How did the Tyrannosaurus get its food?

What does Tyrannosaurus eat to live

What kind of food do Tyrannosaurus eat?

What sort of food did Tyrannosaurus eat?

...

and many other interpretations ?

Implies simple patterns and user guidance are not enough

Language Understanding

Natural Language Understanding

- Finding Intentions and Parameters
- Analyzing 300M Search Queries / Day
- Language Variability Issues: Patterns + ML
- CNN-based Domain Detection
- 42 Major Domains / 347 Sub Domains
- 3,400 Properties, 4.8M Paraphrases for Patterns

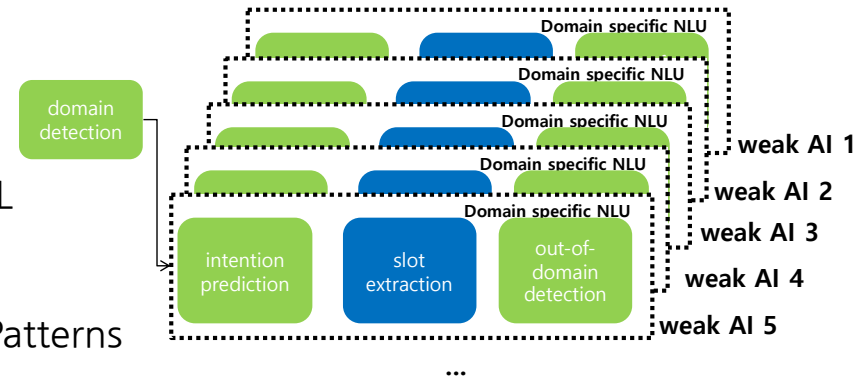

`inform:weather` <address>경기도 화성시</address> <datetime="WE">주말</datetime> 날씨

`inform:weather` <datetime season="PRESENT_REF" mod="APPROX">요즘</datetime> <country>라오스</country> 기후는 어떤가요?

`inform:musician` 가수 <name>신용재</name>가 있는 그룹 이름이 뭐였지?

`convert:length` <unit value="130" unit="INCH">130인치</unit>가 <unit name="METR">미터</unit>로 하면 얼마지?

Query Rewriting : enhancing recall and accuracy

Utilizing query reformulations in the session logs

Lexically

Spelling correction

Semantically

Domain-aware

Relation-aware: Artist and Song, Album and Song

Context-aware

Location and Contacts: Near Places, Frequently contacted Friends

Implicit Verification

Did you mean?

Displaying related queries

Mostly short and ambiguous queries

top 1, 2 queries of the smart set-top box are one word (Youtube, Porroro)
leveraging search users' preference to know most likely intention of a query
same domain/service but different object

Play 'Signal'

Mobile app

N 시그널

통합 블로그 카페 지식IN 이미지 동영상 어 ...

연관 시그널하트, 하트시그널 시즌, 트와이스 시그널, 시그널2, 하트시그널, tvn 시그널, 보이스, 하트시그널2 출연자, 시그널 ost, 비밀의숲

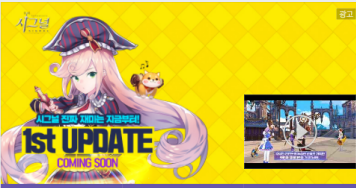

구글스토어 앱스토어 공식카페

TV Series

방송 프로그램 정보

시그널
드라마 | 15세이상

편성 tvN 2016.01.22. ~ 2016.03.12. 16부작
사이트 공식홈
시청률 최고시청률 ①
12.5% 닐슨코리아 | 12.8% TNMS

다시보기 TV연예

TALK 259,388 + 구독 37,602



Music

네이버 뮤직 ① 다른 사이트 더보기

SIGNAL
SIGNAL - TWICE(트와...
2017.05.15. ♡ 25,048

가사 > 데이터랩 > 뮤직비디오

회상
시그널 OST Part 1 장범준
2016.01.30. ♡ 6,783

가사 > 데이터랩 >



NAVER Search → Integrated Search

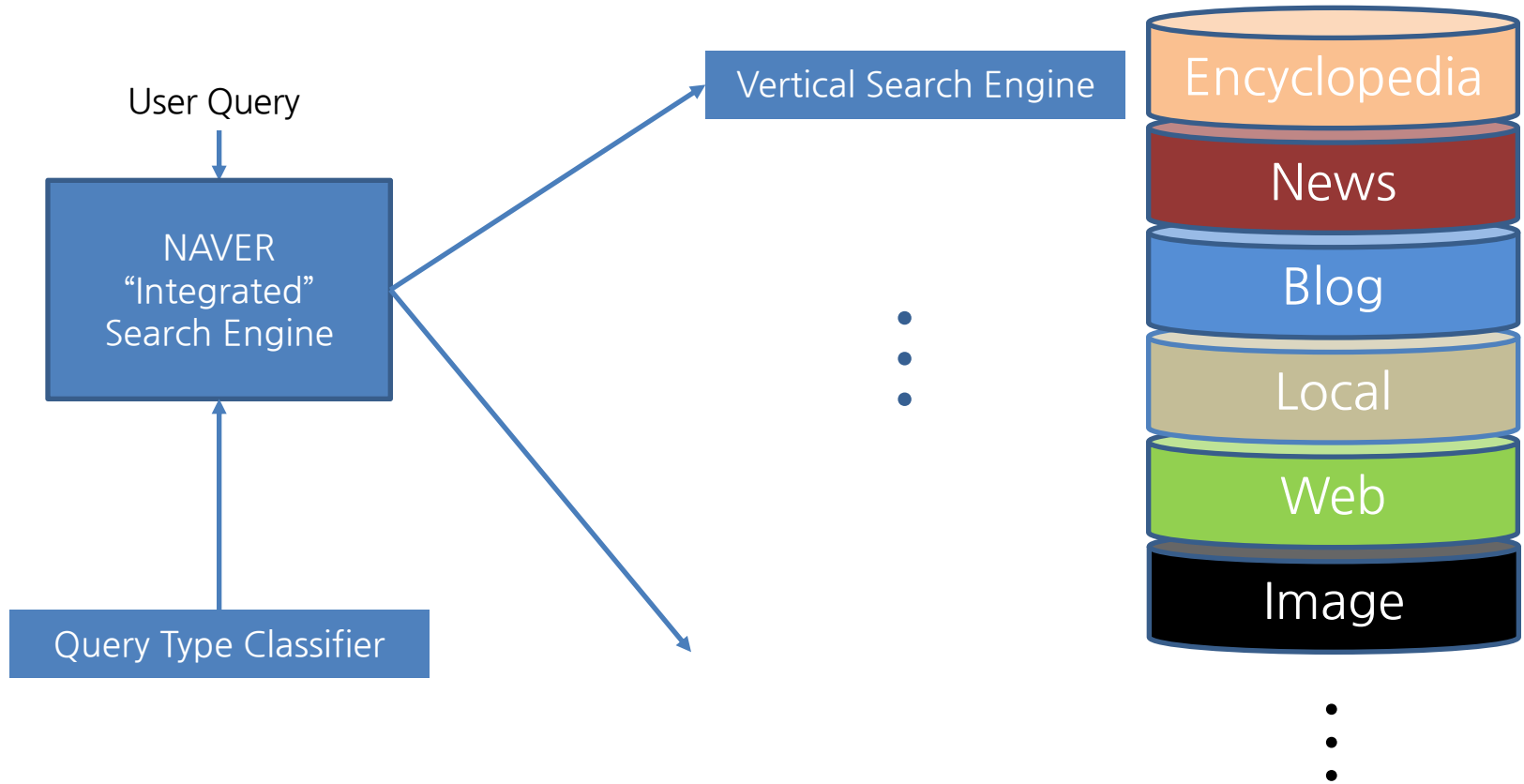

Recency (Steady, Trending, ...)
Navigational, Transactional, Informational
Query Category (Place, Shopping, ..)

NAVER SERP Examples (Query: BTS)

Merging and Ranking, according to the top intention

The screenshot shows the Naver search results for the query 'bts'. At the top, there are navigation tabs for '통합' (Integrated), '뉴스' (News), '이미지' (Image), '동영상' (Video), and '실' (Real-time). Below this, there's a 'Content DB' section with a grid of news items. The first item is '연단 방탄소년단, bts 부산공연, bts 뜻, bts 지민, 부산 방탄소년단, bts 웹툰, 이미, bts 소속사, ...'. The second item is '방탄소년단' with a 'STARCAST' badge and '14,607,002' views. Below the news items, there are album covers for 'A Brand New Day', 'Dream Glow', and 'MAP OF THE SOUL'. At the bottom, there are tabs for '앨범' (Album), '곡' (Song), '공연' (Performance), and '방송' (Broadcast).

Content DB

The screenshot shows the Naver News search results for 'bts'. The title is '뉴스' (News). The top article is '케이프투자증권 "넷마블, BTS월드도 흥행 기대감 상승"' (Keyp2 Securities "Netmarble, BTS World also expected to rise in sales"). The article text mentions '케이프투자증권은 20일 넷마블 (251270)에 대해 글로벌 모바일 게임시장에 정식 출시되는 기대...' and '5시간 전 뉴스스 네이버뉴스'. Below this, there are more news items, including '넷마블 추가 상승 예상, 'BTS월드'의 글로벌 흥...' and '틴초아시아워즈 후보에 BTS-블랙핑크-NCT127-엑소'.

News

The screenshot shows the Naver Blogs search results for 'bts'. The title is 'VIEW'. The top article is '2019.06.20. ..._YuM's LoG... 44분 전'. Below this, there are several blog posts, including '[방탄소년단/BTS/정국] 58585858 정국 58' and 'Magic Shop 2시간 전'.

Blogs

The screenshot shows the Naver Videos search results for 'bts'. The title is '동영상' (Videos). The top video is 'BTS Live : 행복 한 시간 후 여유...' with a duration of 51:04. Below this, there are several other video thumbnails, including 'BTS Live : 부산 이 보라색', 'BTS Live : VOP E 케잇-', 'BTS Live : 오렌 만이예요', and 'BTS Live : 미니 모니'.

Videos

The screenshot shows the Naver Music search results for 'bts'. The title is '네이버 뮤직' (Naver Music). The top result is 'A Brand New Day (BT...)' by 방탄소년단. Below this, there are several other music-related results, including '작은 것들을 위한 시 (Bo...)', '소우주 (Mikrokosmos)', and '파워링크'.

Music

Ads

The screenshot shows the Naver Web search results for 'bts'. The title is 'Web'. The top result is '방탄소년단 | 트위터.com > bts_twt'. Below this, there are several other web-related results, including 'BTS official (@bts.bighitofficial) • Instagram 사진 및 동영상', '방탄 - 나무위키', and 'BANGTANTV - YouTube'.

Web

Images

NAVER SERP Examples (Query: TheTuna)

Merging and Ranking, according to the top intention

The참치

통합 지도 이미지 VIEW 동...

연관 더참치

THE참치 생선회
리뷰 99 분당 정자동 맛집 가족들과 다녀온 ...

전화 저장 길찾기 공유

경기 성남시 분당구 정자동로 135 **복사**
[지번] 정자동 162-2 푸르지오시티 3차 D동
201호 지도 내비게이션

매일 17:00 - 24:00
일요일 휴무

데일리메뉴	39,000원
더참치메뉴	59,000원
세프 메뉴	89,000원
비อนด์ 메뉴	119,000원

메뉴판(원산지) 전체보기

단체석, 주차, 포장, 예약

DataLab.
찾는목적 푸진레스토랑, 데이트
목요일 시간대별 검색 인기도

최고 인기 19:00

00 02 04 06 08 10 12 14 16 18 20 22

Local

Blogs

VIEW

전체 카페글

[정자동맛집] 정자동 **the참치**에서 행취 먹고음 존맛탱...또먹고싶다
맛있었을 우린 예약하고 가서 세팅 다 되어있구 톨으로 안내받을 또가고싶다ㅠㅠ 다음회식 또 ...
문쓰는게 제... | 2019.01.09.

#정자동맛집 #분당맛집 #정자동the참치 #the참치

분당참치맛집 / 더참치 **The참치**
아무리 봐도 참치집보다는 레스토랑 느낌이잖아?!!!! 진열된 와인잔부터 테이블... 그럼 지금...
에크리스탈이 | 2017.12.21.

#분당정자동맛집 #분당참치맛집 #the참치 #the참치

[더참치] 분당 정자동 참치 맛집 **THE참치**
참치는? 하길래 '완전 좋아' 검색 의 황께서 알아본 정자동 푸르지오 시티에 있는 **THE참치**... 2테...
LUV ME 1... | 2019.03.04.

#더참치 #THE참치 #분당참치맛집 #정자동참치

참치와 스테이크를 한번에?? 정지역 **The참치**
주말에 티비를 보고있다가, (생생 정보들이었던 것으로 기억) 이새 참치와스테이크... 캐세주고 있었는...
14

Images

사진요약 7

DataLab 빅데이터 분석을 통해 생성된 결과입니다.

#스테인마크 #슈프 #더참치

사진요약 더보기 →

뉴스

관련도순 · 최신순

[유현준 칼럼] 영화 'The MASK MAN' : 영화 'The MASK MAN' 이미지 환상필름이 제작한 영화 은 흥준 최 감독이 연출했고, 배우 박재...
2일 전 뉴스포인트

히말라야에 버리고 간 '양상'. 산소통-참치 캔-항택 산더미
'지상에서 가장 높은 쓰레기장(the highest garbage dump)'에 베레스트. 지난달 30일 이후 사...
2019.04.13. 중앙SUNDAY ...

英·EU 韓수산물 교역 시장 동향...KMI, 'K-Fish Around The Globe' 발간
Around The Globe' Vol.13을 발간했다. 브렉시트는 영국이 EU로부터 탈퇴하는 것을 의미하는...
2019.05.02. 뉴스1 네이비뷰...

코트야드 매리어트 서울 보타니파크, 봄맞이 무제한 제철 참치뷔페 프로모션 선포
제철인 참치를 무제한으로 즐길 수 있는 '참치는 내가 사게' 뷔페 프로모션을 선보인다고 밝혔다...
2019.03.18. 투어타임즈

뉴스 더보기 →

함께 많이 찾아본 곳 10

News

Web

The Tunas - 더 튠스 페이스북
www.facebook.com/bandthetunas

The Tunas - 더 튠스 :: 참치들, 대구. 좋아하는 사람 864명 · 이야기하고 있는 사람들 1명. The Tunas 넓은 대양을 거침없이 헤엄치는 참치들 거...

더참치(**the참치**) - 포스퀘어
ko.foursquare.com/더참치the참치...

더참치(**the참치**) 해산을 전문점 및 일본 음식점 WWW역삼1동 자정 공유집 5 사진 34 5.8/10 9 평가 친구들이 더참치(**the참치**)... Pretty grea... 포스퀘어

고추참치 YouTube
www.youtube.com/channel/uc83d3ie...

약 6만 명의 구독자를 보유한 고추참치 YouTube의 유튜브. 약 4천 개의 동영상상이 있습니다. '유튜브' 및 '카카오TV'에서 (동시송출) 게임 종합방...

참치 - 리그베다위키
rigvedawiki.net·참치

참치 최종 변경일자: 2015-04-09 11:52:55 기여자 보기 독자 [-] 1. 어류 1.1. 이름의 기원 1.2. 식량으로서의 참치 1.3. 참치 수은 관련 1.4. 위험...

더보기 →

동영상

[예고] Where is the 참치? 공귀...
도시아부 내이비TV
▶ 1만+ | 2019.01.07.

[도시아부 예고] Where is the ...
채널A.H... | Youtube
▶ 4천+ | 2019.01.07.

Videos

Clova: Results based Prediction

Predicting a domain using sub-results of each domain

Especially, effective for Informational needs

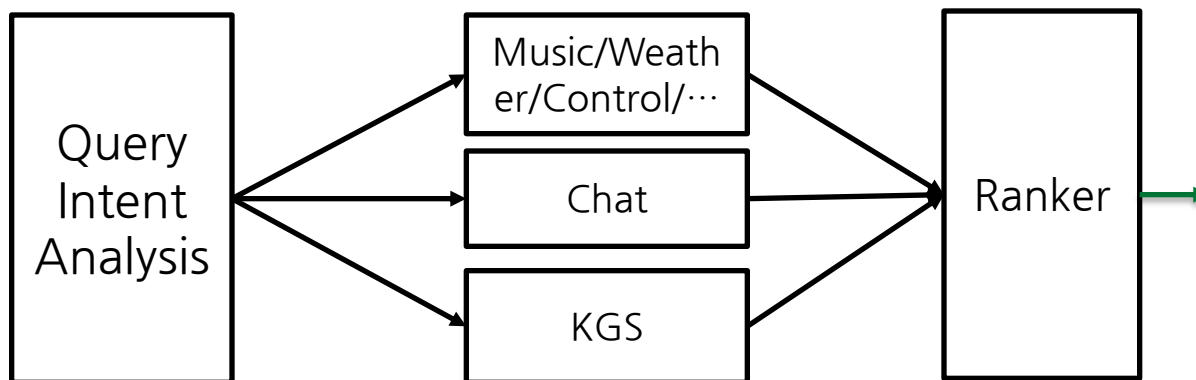

マリオメーカー
마리오 메이커 (Mario Maker)

Hard to determine using only utterance itself

すみません、わかりませんでした。
죄송합니다. 모르겠습니다. (I am sorry I have no idea)

ウィキペディアによると、『スーパーマリオメーカー』は、任天堂より2015年9月10日に発売されたWii U用 …
위키피디아에 따르면, “슈퍼마리오 메이커”는, 닌텐도로부터
(According to wikipedia, Super Mario is made by Nintendo…)



“User-centric Q&A platform”

Anyone can share any kind of knowledge, know-how and tips.

 **팝송 노래 제목 알려주세요!** A 1

 sala**** | 질문 12건 | 질문마감률 16.7% | 질문채택률 16.7% | 2017.05.02. 14:15 조회 1,952

앨범재킷 사진이 기억나는데,, 전체적으로 붉은색느낌이고 외국여성분이 얼빡으로 있었어요,, 눈내리같이 있었던거 같고,,(아마 흑인분이었던것 같고,,

노래 시작은 여자 목소리로 으으으으으으 울더스토리~~~,,으흐음 저스트 어퍼고 저퍼고~~~

엄청 유명한 노래인데 제목을 모르겠어요,, 노래 뒤에 "II"이거 있었던거 같아요,,,,, 모르겠쵸 죄송합니다,,,



What is the title of this song?

*I came across this song.
The color of the album jacket is totally red and a woman is looking down.
The song starts like 'u.u.hu.u.u.um ... all the story...'
I remember the title ends with 'II'*

 **질문자 채택** **곰돌이님 답변입니다.** 친구

채택답변수 61 | 2017.05.02. 14:57

Rihanna - Love The Way You Lie (Part II) (Feat. Eminem)
입니닷 ㅎㅎ

 **Love The Way You Lie (Part II) (Feat. Eminem)**

아티스트 Rihanna
앨범 5집 Loud | 2010.11.15.

On the first page of our story
the future seemed so bright
then this thing turned out so evil
I don't know why I'm still surprised
even angels have their wicked schemes
and you take that to new extremes
but you'll always be my hero
even though you've lost your mind



Rihanna - Love The Way You Lie (Part II)



Clova Brain - Clova Q&A

KG-based Q&A

Wikipedia, Encyclopedia, News & Blog

cQA-based Q&A

FAQ matching with semantic matching

Knowledge-iN, and manually answered documents

Vertical Q&A

Movie/drama title and episode Q&A

Semantic based Matching

- Using 25M QA documents to embed a query to a vector
- Top score on Quora and SNLI dataset

The screenshot shows a Naver Q&A interface. At the top, there's a green header with the Naver logo and '지식iN'. Below it, a search bar contains '지식 Q&A' and a '질문하기' button. The main content area is titled '의료상담 > 피부과'. A question titled 'Sun Allergy' is highlighted with a blue box. Below the title, it says '비공개 · 질문수 142 · 마감률 66% · 채택률 62%' and '답변 3' with a thumbs-up icon. The question text is 'No matter how much I wear sunscreen, If I go outside in the summer, my legs are red and very sore. Am I allergic to sunlight', with 'allergic to sunlight' highlighted in a red box. At the bottom, there are buttons for '의견 0', '나도 궁금해요', and '신고'. A date '2016.06.01' is visible at the bottom left.

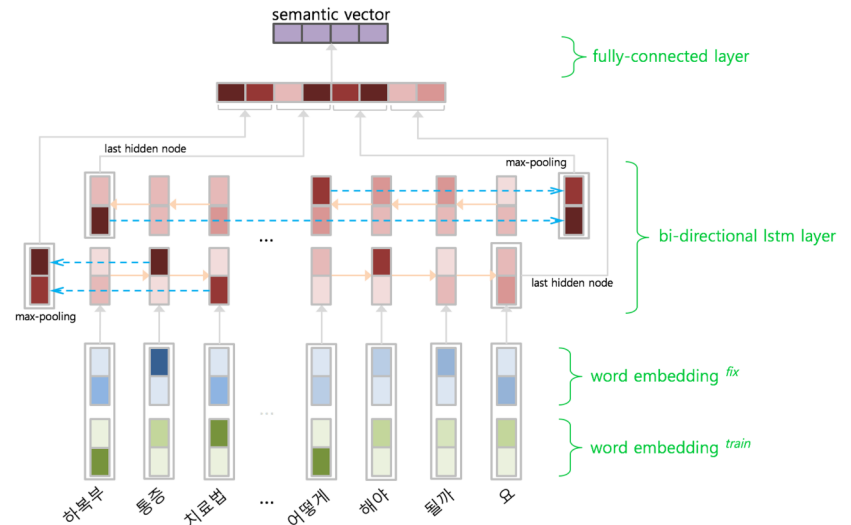

Kim, et. al, "Semantic Sentence Matching with Densely-connected Recurrent and Co-attentive Information", AAAI 2019

Song, et. al, "Translation of Natural Language Query into Keyword Query Using a RNN Encode Decoder", SIGIR 2017

Kim, et. al, "Question Retrieval using Deep Semantic Matching for Community Question Answering", HCLT 2017

Question Embedding - cQA based Q&A

Providing previous QA
 User-feedback based learning
 Got the highest level in 1.5 year

네이버에 질문하는 법 60
 shiny smile · 마감률 100% · 채택률 100% · 2017.08.26.

답변 3

네이버에 이처럼 질문하는 법을 더 자세히 알려주세요^ ^

나도 궁금해요

답변 3개

네이버에 문의하는법 20
 kwon**** · 마감률 100% · 채택률 100% · 2017.02.06.

답변 1

제가 지식인관련으로 문의를 할려고합니다. 네이버에 문의를 할려면 어디로 문의를 하면되나요?이 메일을 보낸다면 주소를 알고 싶습니다. 제가 다급해서 이 질문을 올립니다.

의견

나도 궁금해요

답변 1개

깊은샘님 답변
 우주선 · 열심 · 채택답변수 14,537
 2016 경제 분야 지식인
 활동분야 : 주식, 증권, 컴퓨터 부품, 조립, ...

안녕하세요. ●깊은샘●입니다. 반갑습니다 지식인 관련 문의 하기 원하시는 것 같습니다. 아마 대부분 찾아서 해왔을 것 같구요. 그런데 지식인 고객센터가 있습니...

출처 http://kin.naver.com/qna/detail.nhn?d1id=1&dird=...
 2일 전

지식인 Ai
 지식인 지식인 로보타이더, 후원 서비스

지식인 지식인에서 처음 선보이는 지식인 로보, 후원 서비스예요.

여러분의 지식인에서 질문하시든, 지식인 로보가 질문 내용을 분석, 학습을 해서 답변을 추천해 주는 서비스입니다.

로보가 아직 학습과 단계이지만, 계속 학습을 해서 여러분의 궁금증을 해결해 드릴 수 있게 하겠습니다.

- 지식인 http://kin.naver.com
- 공식블로그 http://blog.naver.com/kin_brand

주요활동분야 :
 주요활동분야가 없습니다.

주요활동분야는 채택답변이 두개 이상 있는 2단계 이하 단계로의 총 해서 최대 5개까지 선택할 수 있습니다. 지식을 대표할 수 있는 주요 답변자는 단계로사로 설정해주세요.

16%

내공 12,000,798

절대신

214,324	156,068	88.0%
문제답변	채택답변	답변채택률

- 내공순위 : 19,400위
- 질문 : 채택이율 1건
- 답변추천 : 총이율 5,843
- 채택이율 : 100%
- 채택이율 : 100%
- 채택이율 : 2,262

도움받은 사람 수 196,133

친구로 추가할 수 2,375

내공 0 1,501 100,001 600,001 5,000,001

하수 상수 시인 조수 중수 고수 명용 지존 최인 지물신 비당신 물신 달신 달신 태양신 권화신 우주선 수호신 절대신

절대신

총입력문	절대신 평균
내공 5,000,001	5,867,861
채택답변수 50,000개	62,911개
채택답변률 50%	95%

Search by Image

NAVER 지식iN 검은색 고양이 품배이

홈 새글문 지식Q&A 오문사전 사람들 베스트 마이저식 지식iN연동 오늘의질문 교육기부

생활 > 반려동물 > 고양이 > 고양이

원문보기 ON OFF

재미와 감동으로 화제가 된 Q&A 지식iN답장지에서 확인하라! 자세히보기

Q 검은 고양이 품배이인지 코숏인지 알려주세요! 10

비공개 | 질문 10건 | 질문마감률 86.7% | 질문채택률 86.7% | 2017.01.04. 21:21 | 조회 79

A 2

분양 처음받을때 체인점가서 했고, 품배이라고 알려주셨거든요! 분양서류? 같은거에도 그렇게적혀있구요.

근데 품배이인지 아닌지 확실히 모르겠어서요. 품배이같기도하고 코숏같기도해서.. 털은 엄청 윤기나는 검은색인데, 안에 피부살색같은 하얗거든요. 밝은정도가아니라 진짜 거의 하얀진주색이에요... 얼굴은 작은데 털모양??이 둥글둥글하게 되었어요!! 몸모양은 길게 쪽빠졌는데 애가 힘이 엄청세요.. 그래서 들면 어떻게든 발버둥쳐서 빠져나간적도있고. 근육량이 많은거같아요...; 8개월쯤 됐다는데 덩치는 코숏 또래랑 비슷한데 길이는 애가더길어요.. 근데엄청먹어요..

처음에 허약질 엄청하고 할필당해서 통터도났는데.. 파양한번 당했던애라 그런거같고.. 애가 엄청울어요.. 밤만되면 날라다니고 울고 만져달라고 아양부리고하는데 품배이성격은 아닌거같은데... 상관은없는데 동물병원데려가서 물어봤을때도 품배이같다고 했고.. 근데 확실히알려구용ㅠㅠ!! 품배이가 안흔한종이잖아요. 품배이에대해 많이검색하고 찾아봤는데 진짜 모르겠어서 남기는거예요..!!



Want to know the breed of a cat



Computer Vision

Smart Lens: DNN-based Visual Search
 Collaborating with NAVER Labs Europe (Fashion, Visual, Search, and so on)

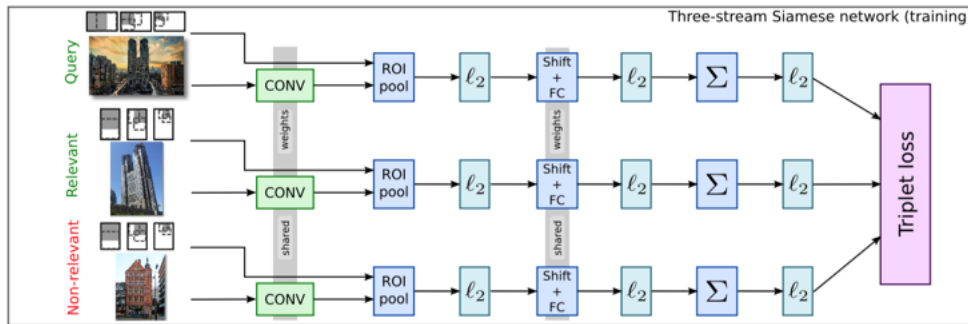

DNN-based Image Recognition Framework

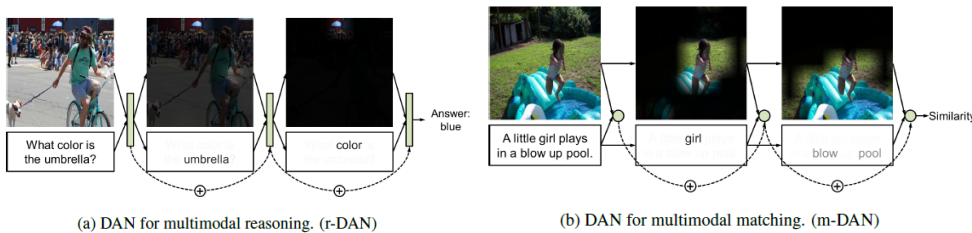

Clova & LABS Europe

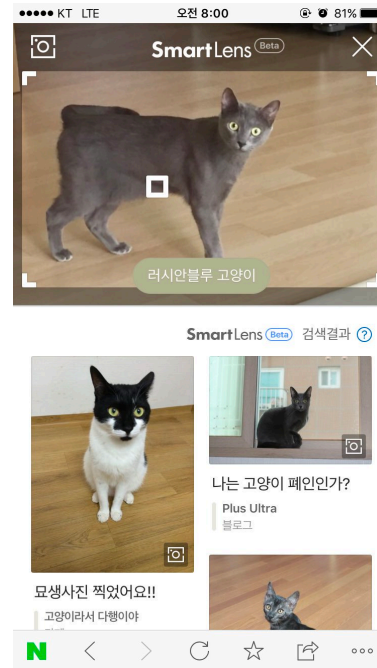

Smart lens



Shopping lens

Matching Images - Visual Question Answering

The screenshot shows a Naver Knowledge+ Q&A page. The question is "어떻게 생긴 고양이종이 뭔가요?" (Which cat breed looks like this?). The user provides a drawing of a cat with a unique, elongated body and a tail that curls upwards. The page includes a search bar, navigation tabs, and a list of related questions and answers.

Q 어떻게 생긴 고양이종이 뭔가요? 10

mkse**** · 질문 52건 · 질문이감률 69.7% · 질문채택률 69.7% · 2019.10.16. 00:08 · 조회 802

제가 TV에서 잠시동안 본 고양이인데요. 아무리 뒤져봐도 언나오길래 꿈에서 본것지 긴가민가 할정도.. 비슷한걸 찾아봤는데 서벌고양이 검은색이 조금 비슷한데요 그거보다 좀 비현실적으로 생겼어요 귀 사이에 틈이 별로 없고 저만색털에 노란눈이있던거 같네요 혹시나. 아시는분은 답변좀ㅠㅠ 막 머리통 모양이 저렇네요



새질문 [5/23]

고양이 내가 놓친 질문

- 고양이 분양, 필요한것
- 고양이 눈동
- 개 목덜미 잡고 물리는 행동
- 우리 집고양이 어째서 돌기? 담여리 같은게-
- 새끼집고양이
- 양친고양이종성하

고양이 추천자료 [5/23]

- 왜 하필 '고양이와 쥐' 인걸까요?
- 고양이 행동서 보는법
- 고양이를 분양 받고나서 문제가 발생..
- 고양이가 볼 수 있는 색깔?
- (고양이)고양이에게 우유를 먹였는데..
- 고양이는 꿈을 꾸나요?

관련 지식백과 [5/23]

베로크 미술 속 고양이

[고양이 모델로 보는 변화된 예술가] 알력

Not yet, but we are trying...

Using relevant movie reviews

Current accuracy 85%

grandfather with dementia and robot

main character is hitting a drum

losing memory every 10 min.

13 becomes 30 years old

surviving on a lifeboat



1. 로봇



1. 위플래



1. 메멘토



1. 완벽한 그녀



1. 라이프 오브 파이



2. 올 미즈 로스트



3. 캡틴 필립스

Share everything with your friends

Ask friends and experts directly and verbally

Leveraging your network

Wide range of services all over the world





People



location



Information ▶ People

Influencer Search

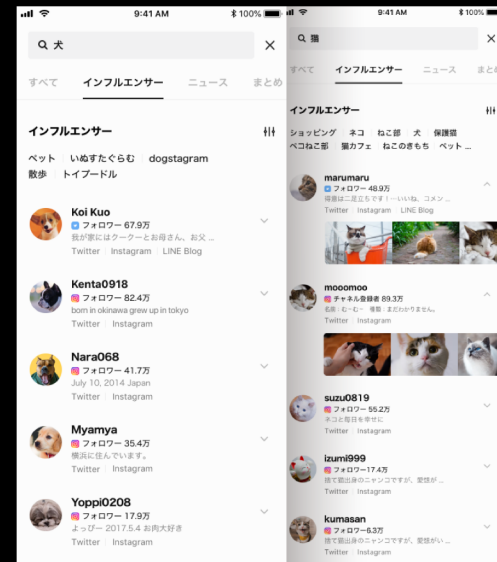

Communication Search

Contents Search

Chat

Open Chat

Official Account

Timeline



LINE NEWS

Weather

LINE Manga

LINE MUSIC

Celebrities

LINE Shopping

A woman with long dark hair, wearing a grey blazer and a patterned top, is smiling and looking at a laptop. She is in an office environment with a blurred background. A man in a white shirt is partially visible on the right side of the frame.

1 to 1 Platform

LINE ASK me



LINE ASK me

Search

Discover

Action

Talk Fortune

Over 1,000 fortunetellers



Talk Care

Over 200 experts
in diverse fields

(mental care, career, business, love)



Concluding Remarks

Come and Grow with us

We are expanding fast with offices in Korea, Japan, France, HongKong and more happening now

<https://clova.ai/en/research/careers.html>

-
End of Document

-
Thank You.

-